





INDEX

INSPIRATION	4
FEATURES AND OPTIONS	8
B-24 ELITE / PRESTIGE	10
B-27, B-27 ELITE / PRESTIGE	12
B-28, B-28 ELITE / PRESTIGE	14
B-35, B-35 PRESTIGE	16
B-38, B-38 PRESTIGE	17
B-50	18
B-50 XL	19
B-29	20
TWINSTOR	21
B-34 (XL)	22
B-40	23
B-20, B-21	24
WINDBLOCKER	25
B-126	26
B-127 VERANDA	27
B-127 PERGOLA	28
B-128 PERGOLA	29
B-128 VERANDA	30
TOPSCREEN	31
ZIPSCREEN	32
B-1200 ZIP	34
CORNER SCREEN	35
CABLE SCREEN	36
STANDARD SCREEN	36
B-2100 DROP ARM AWNING	37
OPTIONS AND TECHNICAL INFO	39

BRUSTOR-GUARANTEE

All Brustor products are thoroughly tested to the highest quality standards. Our installers are highly qualified professionals who undergo continuous product training. They are responsible for a perfect installation and excellent after sales service. Thanks to this approach all Brustor products are guaranteed for a period of 5 years. On request the terms of the guarantee can be obtained from your local dealer.

More info about the guarantee on all parts, see page 9.





Create a
comfortable atmosphere
inside and out



FEATURES AND OPTIONS

PERSONALIZE YOUR AWNING

Do you want more comfort or to personalise your awning? Choose from our wide range of options. For example add some LED lighting for an atmospheric effect or a patio heater which will warm your guests on cooler evenings. Or increase the shading on your patio by adding an extra valance.

You can add your ultimate personal touch by choosing your favourite colour for your awning. Beside the standard colours, it's possible to choose from every available RAL colour. Perfectly adapted to your home and garden. Finally, you can also choose from some practical options like a remote control, ceiling fix brackets or lead rail support for an instant added value!



CHOICE OF ARMS	STANDARD	ELITE	PRESTIGE
Max. load elbow	100 kg casted alu parts	105 kg casted alu parts	130 kg drop forged alu parts
Height of the arm	66 mm	71 mm	73 mm
Thickness of profile	2,5 mm	2,5 mm	3 mm
Wind resistance	till 39 km/h	till 39 km/h	till 49 km/h
Possible for	B-25, B-27, B-50, B-21	B-24, B-25, B-27 Elite, B-35, B-38, B-50 XL	B-24, B-25, B-27, B-35, B-38 Prestige
LED lighting	beneath the cassette	LED in the upper and lower section of the arm	LED spot in arm elbow

Choice of retractable arms
No parts are as important as the folding arms. They support the fabric, they roll it in and out and are even hosting LED lights. Wind, large projection: each application has its specific retractable arm.

Guarantee

- 5 years on the cassette and parts.
- 10 years on the moving parts of the awning.
- 2 years on LED lighting and heaters.

Lead rail support
(Depending on the type of awning)
When the awning is rolled out and the front profile has reached its furthest position, that's the point where the awning faces the downward pulling force the most. In order to give the awning more stability and resistance, two integrated support legs can be optionally mounted.

Heating
When the temperature drops, a pleasant radiant heat can bring comfort. A 2000W patio heater makes it appealing to enjoy outdoor life until even long after the warm summer days.

LED lighting
An ambient LED lighting can be added to almost every awning and even lights up your terrace when closed.



Valance
Sometimes the projection is insufficient to create the desired shadow. An extra valance on the front increases the shadow surface extensively.



Remote control
Each awning is equipped with a motor that controls the respective parts. This motor can be optionally driven by means of an RTS transmitter with one or more channels. This remote control is included for some awnings.



Wide choice of colors
The awnings are available in a range of standard colors. Brustor offers its customers additional choice between all RAL colors.



B-24 ELITE B-24 PRESTIGE

Are you searching for a robust awning? The B-24 Elite and especially the B-24 Prestige will fit your needs. The B-24 Prestige is resistant to a wind force of 6 Beaufort and offers shade and shelter under various weather conditions.

B-24 Elite and the B-24 Prestige are equipped with powerful folding arms fitted with 4 steel cables, providing a shadow range up to 3,75 m. In addition to comfort, these awnings are also creating an ambient place. And what do you think of optional LED lighting and heating?

More options and specifications on page 39.

- The 'heavy duty' awning
- Elegant finish with aluminum side plates without visible screws
- Fully enclosed cassette for optimal protection during various weather conditions
- Maximum width of 7 m and 14 m when coupled
- Compact and contemporary design



B-24 Elite:

- 4 cables in the folding arms for a better fabric tension
- Projection up to 3,75 m
- Option: LED strip in upper and lower arm or under the cassette



B-24 Prestige:

- Most robust solution
- Projection up to 3,75 m
- Option: LED spot in elbow of the folding arm or under the cassette

Dimensions

	B-24 Elite	B-24 Prestige
Width:	min. 2,05 m - max. 14,00 m (coupled from 7 m)	min. 3,53 m - max. 14,00 m (coupled from 7 m)
Projection:	1,50 m - 2,00 m - 2,50 m 3,00 m - 3,50 m - 3,75 m	3,00 m - 3,50 m - 3,75 m
Operation:	Somfy RTS or IO motor	Somfy RTS or IO motor with remote control
Cassette:	22,0 cm high x 14,7 cm deep	

Standard colors Elite

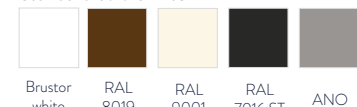

All other RAL colours optional.

Standard colours Prestige

All RAL colours.

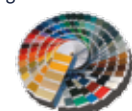

B-24 ELITE
AND PRESTIGE



B-24 ELITE
AND PRESTIGE



B-27 B-27 ELITE B-27 PRESTIGE

Retractable awnings B-27 Standard, Elite and Prestige distinguish with their contemporary rectangular shape. All three models are very suitable for modern houses and can also be built into the façade. They're technically identical to the B-25 models in Standard, Elite and Prestige. There are five standard colours, while 200 other RAL colours are available as an option to find the colour of your dreams.

More options and specifications on page 39.

- Contemporary, rectangular shape
- Can be built into the façade
- Elegant finish with aluminum side plates without visible screws

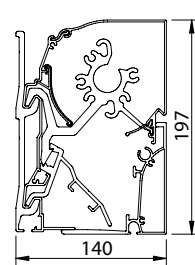

B-27

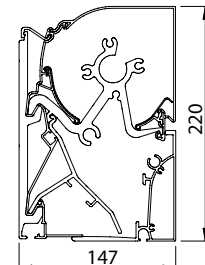

B-27 ELITE / PRESTIGE



B-27 Standard:

- 2 cables in folding arm
- Projection up to 3 m



B-27 Elite:

- 4 cables in folding arms for a better tension of the fabric
- Projection up to 3,75 m
- Option: LED strip in upper and lower arm or under the cassette



B-27 Prestige:

- Most robust solution
- Elbow in drop forged alu parts
- Option: LED spot in elbow of folding awning or LED strip under the cassette

Dimensions

	Standard	Elite	Prestige
Width:	min. 2,05 m - max. 14,00 m (coupled from 7 m)		min. 3,53 m - max. 14,00 m (coupled from 7 m)
Projection:	1,50 m - 2,00 m - 2,50 m - 3,00 m	1,50 m - 2,00 m - 2,50 m - 3,00 m - 3,50 m - 3,75 m	3,00 m - 3,50 m - 3,75 m
Operation:	Somfy RTS or IO motor		Somfy RTS or IO motor with remote control
Cassette:	19,7 cm high x 14,0 cm deep	22,0 cm high x 14,7 cm deep	

Standard colours Standard & Elite



Standard colours Prestige

All RAL colours.





Move the luxury from inside out

B-28 B-28 ELITE B-28 PRESTIGE



The B-28 family is available in 3 different versions. The B-28 series fits any facade because of its compact design.

More options and specifications on page 39.

- Elegant finish with aluminum side plates without visible screws
- Maximum width of 14 m when coupled
- Fully enclosed cassette
- Compact design

- 5^{BH}** B-28 Standard:
- 2 cables in the folding arms
 - Projection up to 3 m

- 5^{BH}** B-28 Elite:
- 4 cables in the folding arms for a better tensioning of the fabric
 - Projection up to 3,75 m
 - Option: LED strip in upper and lower arm

- 6^{BH}** B-28 Prestige:
- 4 cables and elbow in drop forged alu parts
 - Most robust solution
 - Projection up to 3,75 m
 - Option: LED spot in elbow of the folding awning

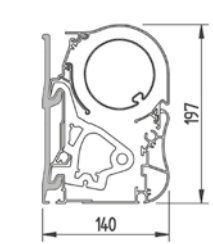

B-28

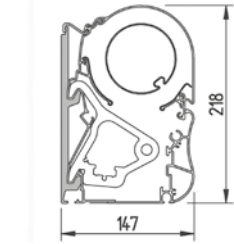

B-28 ELITE / PRESTIGE

Dimensions	Standard	Elite	Prestige
Width:	min. 2,05 m - max. 14,00 m (coupled from 7 m)		min. 3,53 m - max. 14,00 m (coupled from 7 m)
Projection:	1,50 m - 2,00 m - 2,50 m - 3,00 m	1,50 m - 2,00 m - 2,50 m - 3,00 m - 3,50 m - 3,75 m	3,00 m - 3,50 m - 3,75 m
Operation:	Somfy RTS or IO motor		Somfy RTS or IO motor with remote control
Cassette:	19,7 cm high x 14,0 cm deep		22,0 cm high x 14,7 cm deep

Standard colors Standard & Elite					Standard colours Prestige	
					All other RAL colours optional.	
Brustor white	RAL 8019	RAL 9001	RAL 7016 ST	ANO	All RAL colours.	



B-35 B-35 PRESTIGE

The B-35 and B-35 Prestige are wide wind resistant retractable awnings. The Prestige version can resist up to 6 Beaufort, with a projection of 4 meter.

Retractable awning B-35 Prestige has been developed with a bar system which fulfill the highest quality standards (EN 13561). The Brustor B-35 can resist to a wind force up to 6 Beaufort and has a projection of 4 m, even when the fabric consist of 15 m in one part. You will be sitting very comfortable under the awning even with a strong wind.

As an option, this awning can be equipped with built-in LED lights and heating. As an alternative for the 5 standard colours, you can choose from 200 optional RAL variations and some hundreds of different high quality acrylic fabrics.

More options and specifications on page 39.

- Strong awning with 4 cables
- Bar system with reinforced support tube
- Maximum width of 15 m when 2 awnings are coupled
- Up to 4 m extension



- 5^{Bt}** B-35:
- 4 cables
 - Option: LED strip in upper and lower arm

- 6^{Bt}** B-35 Prestige:
- Standard with Somfy RTS or IO motor with remote control
 - Option: LED spot in elbow of the folding arm

The B-35 awning is available in several versions, varying from an open system (type A) to a fully enclosed cassette casing (type K). Awning B-35 Prestige is available with fully enclosed cassette (type K) or semi-closed (type I).

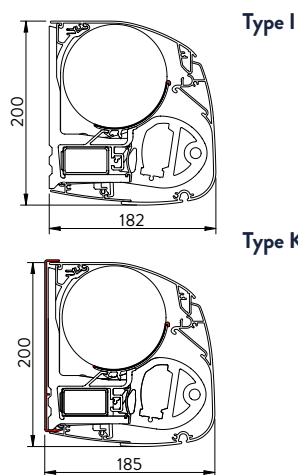

Dimensions	B-35	B-35 Prestige
Width:	min. 2,05 m - max. 15,0 m (coupled from 7,5 m)	min. 3,5 m - max. 15,0 m (coupled from 7,5 m)
Projection:	1,50 m - 2,00 m - 2,50 m - 3,00 m - 3,50 m - 4,00 m	3,00 m - 3,50 m - 4,00 m
Operation:	Somfy RTS or IO motor	motor RTS or IO with remote control
Cassette:	20,0 cm high x 18,2 cm deep	

Standard colours

					All other RAL colours optional.
Brustor white	RAL 8019	RAL 9001	RAL 7016 ST	ANO	

B-38 B-38 PRESTIGE

Are you looking for an optimal protection against the sun, wind or insight? The B-38 and B-38 Prestige are folding arm awnings who provide a maximum amount of shading. The B-38 is an exclusive awning that can resist wind forces up to 6 Beaufort. The variable valance offers a perfect protection against the low sun and offers extra privacy. When not in use, the valance disappears completely into the lead rail. The awning and variable valance can be controlled with one single remote control. Optionally, this remote can also control built-in LED lighting and electric heater.

More options and specifications on page 39.

- Perfect for protection against the low sun or for houses with south-west orientation
- Folding arm awning up to max. 6 m width
- Projection up to 3,5 m
- With roll-up motorised valance up to 1,3 m
- Strong awning with 4 cable arms



- 5^{Bt}** B-38:
- Option: LED strip in upper and lower arm or under the cassette

- 6^{Bt}** B-38 Prestige:
- Standard with Somfy RTS or IO motor with remote control
 - Option: LED spot in elbow or under the cassette

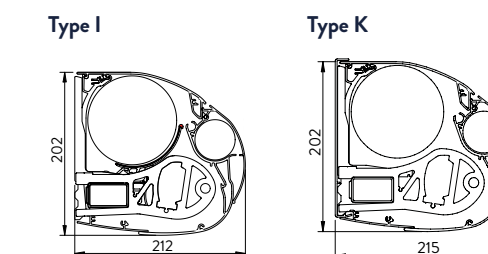

The valance of the B-38 (Prestige) disappears completely into the lead rail...

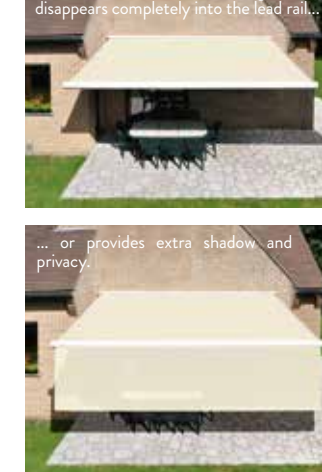

Dimensions	B-38	B-38 Prestige
Width:	min. 2,05 m - max. 6,0 m	min. 3,50 m - max. 6,0 m
Projection:	1,50 m - 2,00 m - 2,50 m - 3,00 m - 3,50 m	3,00 m - 3,50 m
Operation:	motor with wall switch	motor RTS or IO with remote control
Cassette:	20,2 cm high x 21,5 cm deep	
Valance:	variable, up to 1,30 m	

Standard colours

					All other RAL colours optional.
Brustor white	RAL 8019	RAL 9001	RAL 7016 ST	ANO	

B-50

The Brutor B-50 has a compact and fully enclosed cassette casing which excels not only aesthetically but also technically.

The B-50 is available up to 5,50 m width, with a maximum projection of 3 m. The awning can easily be mounted by simply hooking the awning into the wall or ceiling fix brackets. With an easy adjustable nut the inclination can effortlessly be altered up to 45°. The B-50 can optionally be equipped with a remote control, LED lighting, valance and heating.

More options and specifications on page 39.



- Awning up to 5,5 m width
- Easy mounting with wall or ceiling brackets

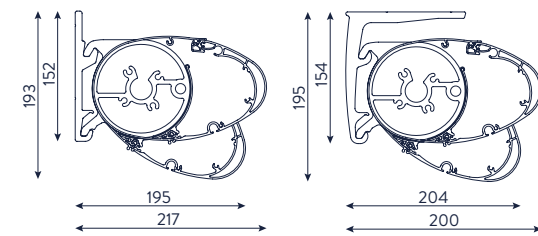

Dimensions

Width: min. 2,05 m - max. 5,50 m

Projection: 1,50 m - 2,00 m - 2,50 m - 3,00 m

Operation: Somfy RTS or IO motor

Cassette: 15,2 cm high x 21,7 cm deep

Standard colours



Brutor white RAL 8019 RAL 9001 RAL 7016 ST ANO

All other RAL colours optional.



B-50 XL

New generation of awnings with extra strong casing and LED strip under the cassette.

The Brutor B-50 XL is the big brother of the compact B-50. Thanks to the more robust cassette, the B-50 XL is available up to 6 m wide and has a maximum projection of 3,50 m. Do you want to add even more atmosphere? You can add optional LED lighting in the arms or integrated into the cassette.

More options and specifications on page 39.

- Extra strong cassette
- Easy assembly with wall or ceiling bracket
- Max. 6 x 3 m or 5,50 x 3,50 m
- Optional LED in folding arms or under the cassette

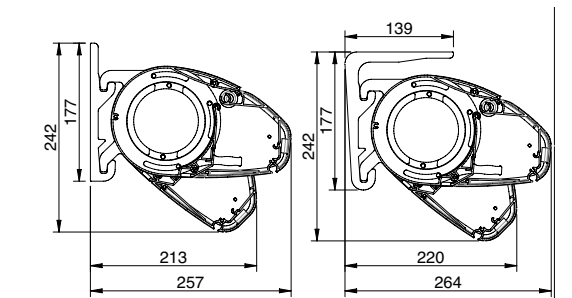

Dimensions

Width: min. 2,05 m - max. 6 m

Projection: 1,50 m - 2,00 m - 2,50 m - 3,00 m - 3,50 m

Operation: Somfy RTS or IO motor

Cassette: 17,7 cm high x 25,7 cm deep

Standard colours



Brutor white RAL 8019 RAL 9001 RAL 7016 ST ANO

All other RAL colours optional.



B-29

Are you searching for an awning to fit your balcony or your house with outward opening doors? The B-29 awning with double pitch arms has been designed to overcome low mounting heights directly above outward opening doors that would damage the fabric with a regular awning. This awning with an extra pitch of 8° is also an ideal solution for balconies or when the sun is low. The full cassette casing made of corrosion resistant aluminum protects the fabric, components and operating mechanism from all types of inclement weather. A dimmable electrical heater and LED lights integrated in the elbow of the arms are available as options which enable you to enjoy longer evenings outdoors.

More options and specifications on page 39.

- Double pitch
- Ideal for houses with outward opening doors
- Projection of 2,5 or 3 m
- Max. width 6 m

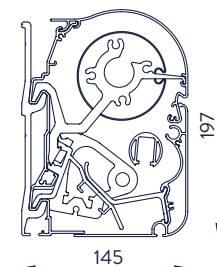

Dimensions

Width: min. 3,05 m - max. 6,00 m

Projection: 2,50 m - 3,00 m

Operation: Somfy RTS or IO motor

Cassette: 22,0 cm high x 14,5 cm deep

Standard colours



Brutor white

All other RAL colours optional.

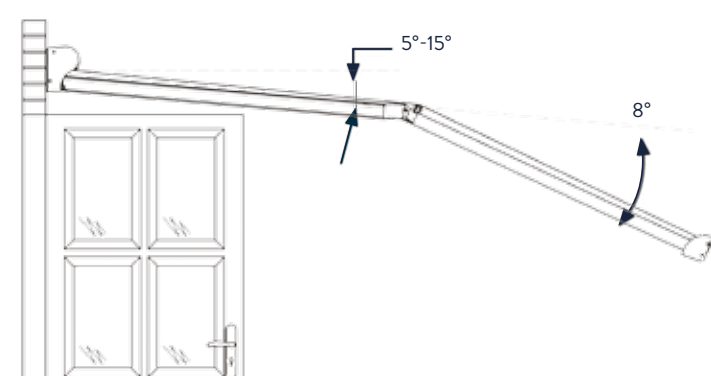

TWINSTOR

The Brutor Twinstor creates shadow wherever you prefer: with two ground anchors or freestanding galvanised steel flowerboxes, this autonomous awning is anchored in the garden or on the terrace without attachment to an existing wall or porch. The fabric and the mechanical parts are protected in an optimal way thanks to the two fully enclosed cassette casings. The arms are electrically controlled with a waterproof key switch or optional remote control.

LED lighting and a patio heater operated by a remote control are convenient when you want to enjoy your Twinstor on cooler evenings.

- Self-supporting structure composed of two B-25 awnings, also available with B-25 Elite
- The eye-catcher on every terrace
- Autonomous awning
- Electrically controlled
- Fully enclosed cassette casings
- Shadow surface up to 42 m²

Dimensions

Width: min. 2,05 m - max. 7,00 m

Projection: 2 x 2,0 m or 2 x 2,5 m or 2 x 3,0 m

Height: standard 2,7 m, in option up to 3,0 m

Operation: Motor with waterproof key switch

Standard colours awnings

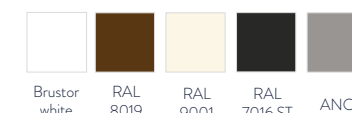

Standard colours frame



RAL 9007 ST

All other RAL colours optional.

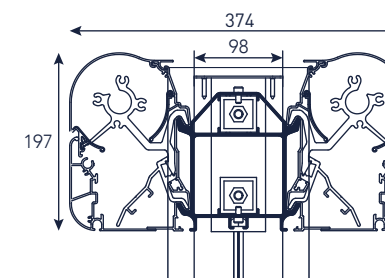

Beside ground anchors, the Twinstor can alternatively be fixed in flowerboxes with reinforcement braces.





B-34 B-34 XL

The B-34 is a budget friendly awning with a maximum width of 6 m and projection of 3 m. The integrated tubular motor is standard, but it can be equipped with gear operation as an option.

More options and specifications on page 39.

- Limited width, large projection
- Max. width of 6 m
- Projection of 3 m

Thanks to the crossed arms it is possible to have a large projection even when the width is limited.

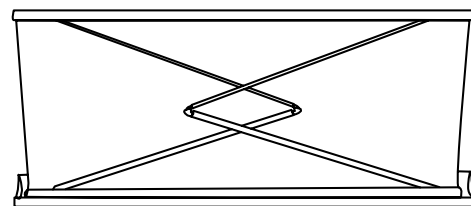

Dimensions

Width: min. 1,25 m with crossed arms - max. 6,00 m

Projection: 1,50 m - 2,00 m - 2,50 m - 3,00 m

Operation: Somfy RTS or IO motor

Cassette: 17,8 cm high x 22 cm deep

Standard colours

 Brutor white
All other RAL colours optional.

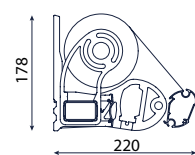

B-34

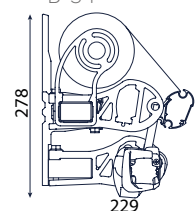

B-34 XL



B-40

The awning B-40 is extremely suitable for the project market. Based upon the B-35 family, this awning has a round design. Two types are available: it can be mounted direct to the wall (type I) or with the help of special supports +/- 10 cm from the wall (type K).

More options and specifications on page 39.

- Folding arms with 4 cables
- Suitable for the project market
- Available in 2 mounting types

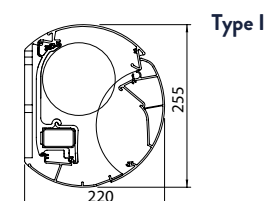

Type I

Dimensions

Width: min. 2,05 m - max. 7,00 m

Projection: 1,50 m - 2,00 m - 2,50 m - 3,00 m - 3,50 m

Operation: Somfy RTS or IO motor

Cassette: 22,5 cm high x 25,5 cm deep

Standard colours

 ANO
All other RAL colours optional.

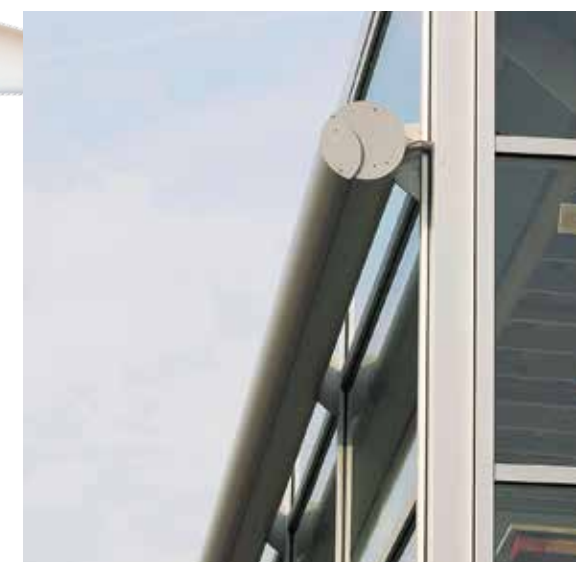

B-20 B-21

Are you looking for sun protection for your balcony? The semi-enclosed cassette awning B-20 with retractable arms for ceiling installation is available with an inclination between 5° and 40°. The almost identical B-21 can be mounted between 20° and 60°, the ideal solution for more privacy and extra shadow. Both awnings are available with a maximum projection of 3 m and a maximum width of 5,5 m. Because of its compact 13,5 cm height, the cassette of these awnings is extremely suitable to be fitted under a balcony.

More options and specifications on page 39.

- Semi-closed cassette
- Projection up to 3 m
- Max. width 5,50 m

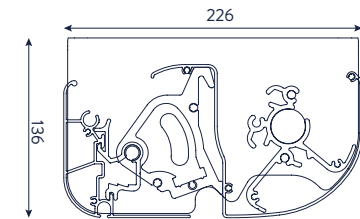

Dimensions

Width: min. 2,05 m - max. 5,50 m

Projection: 1,50 m - 2,00 m - 2,50 m - 3,00 m

Operation: Somfy RTS or IO motor

Cassette: 13,5 cm high x 22,5 cm deep

Standard colours

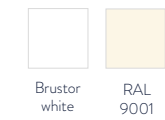

All other RAL colours optional.



B-20:

- Fitted to ceiling
- Inclination between 5 and 40°



B-21:

- Inclination between 20 and 60°
- More shading and privacy

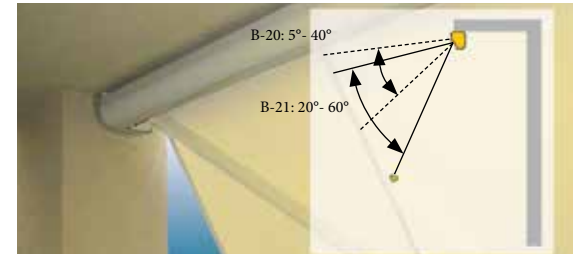

WINDBLOCKER

This horizontal tensioned blind is the ideal solution for a windy terrace and to provide maximum privacy in exposed locations. The Windblocker can also be used to provide angled shade. The height of the handle on the manually operated Bruster Windblocker can be placed at any position on the lead rail. The tensioned fabric can be fixed against the wall or to a pole. A high quality heavy duty spring ensures the fabric remains taut. The stylish cassette casing is made from extruded powdercoated aluminum.

- Windshield for your terrace
- Provides extra privacy
- Manually operated
- Fixed against the wall or to a pole



The new pole encloses the lead rail and provides more stability for the Windblocker.

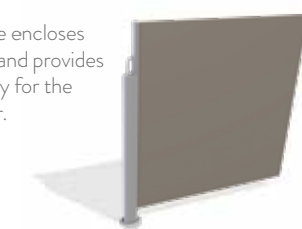

The new foot ensures that the lead rail remains in place and does not roll backwards with strong winds.



Dimensions

Height: acryl fabric: from 1,275 m up to 2,00 m
Soltis 86 fabric: from 1,275 m up to 1,86 m

Projection: 2,00 m - 3,00 m - 4,00 m

Standard colours

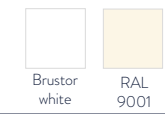

All other RAL colours optional.

1. A locking system ensures the screen stays taut, even with variable wind speed.



2. Stable attachment in supporting pole.



3. Increased ease of use thanks to the built-in support wheel.



4. Option: bonings for a better strengthening, only possible with a Soltis fabric.







B-126

The B-126 is a motorized awning with lateral guides for conservatories, greenhouses and inclined glass roofs. The lateral guide system offers an extension up to 1m25 over the front of your conservatory. The specially designed cassette casing prevents leaves and dirt from getting rolled up in the fabric. The conservatory awning B-126 provides shade up to 5 m wide and 6 m projection with a maximum fabric surface area of 19 m². A coupled version creates shade up to 10 m wide with a maximum fabric surface area of 38 m² (acryl fabric) or 36 m² (Soltis fabric).

- Motorised conservatory awning
- Optional extension up to 1,25 m
- Up to 19 m² of shading

Dimensions		
	B-126	B-126 coupled
Width:	5 m	10 m
Projection:	6 m	6 m
Motor:	1x	
Max. fabric surface area		
Acryl	19 m ²	38 m ²
Soltis 86	19 m ²	38 m ²
Soltis 92	18 m ²	36 m ²

Standard colors			
			
Bruster white	RAL 8019	RAL 9001	RAL 7016 ST

All other RAL colours optional.



Extendable up to 1,25 m

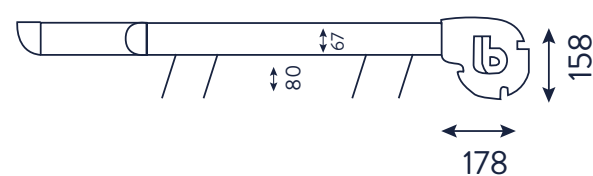

B-127 VERANDA

The B-127 Veranda is a flexible conservatory awning system where the guides can be installed up to 1 m in from the edges of the conservatory. Thanks to the unique design of the B-127, conservatories with bevelled corners can be completely covered.

The B-127 is also available with an extension up to 1,25 m over the front of the conservatory, which provides as an added benefit frontal sun protection. The motorised conservatory awning B-127 offers a maximum width of 6 m, projection of 5 m and fabric surface area of 22 m².

- Motorised conservatory awning
- Extension up to 1,25 m
- Flexible awning





The B-127 can be equipped with an extension up to 1,25 m, which provides additional shading into your veranda.



Dimensions
 Width: max. 6 m
 Projection: 5 m
 Operation: Somfy RTS or IO motor

Fabric surface area
 Acryl: 22 m²
 Soltis 86: 19 m²
 Soltis 92: 18 m²

Standard colours

			
Bruster white	RAL 8019	RAL 9001	RAL 7016 ST

All other RAL colours optional.



B-127 PERGOLA

Remote control included

The B-127 Pergola is a complete self-supporting structure with front support poles and wall fixation. The ideal pergola for your own patio or for restaurant businesses. The B-127 Pergola creates a shadow surface up to 22 m², where your customers can sit back and relax in the shadow or the sun.

- Pergola with self-supporting structure
- Motor with remote control
- The support poles can be equipped with built-in LED lighting
- Max. width 6 m
- Projection up to 5 m

Dimensions			
Height support poles:	2,25 m		
Width:	max. 6 m (Soltis 4,8 m)		
Projection:	5 m		
Operation:	Somfy RTS or IO motor		
Fabric surface area			
Acryl:	22 m ²		
Soltis 86:	19 m ²		
Soltis 92:	18 m ²		
Standard colours			
Brutor white	RAL 8019	RAL 9001	RAL 7016 ST
All other RAL colours optional.			

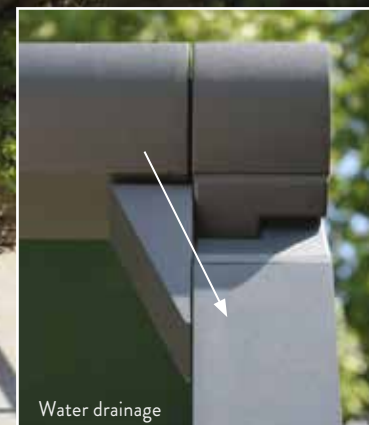

B-128 PERGOLA

SOMFY remote control included

The B-128 pergola is a minimalistic aluminum terrace cover with a sun and rain resistant roof that uses ZIP-screen technology. The system keeps the canvas tightly stretched with efficient tension mechanisms in the side guides for wind resistance, so without sides flapping up. This smooth surface and the minimal slope of 15cm/m ensures that every drop of rain quickly flows into the invisibly integrated gutter in the front profile.

The B-128 has a lot of LED lighting options.

- Light yet robust frame
- Regulate the perfect amount of light, sun shading and ventilation
- Water drainage through supporting posts
- LED lighting in the side guides, the supporting posts or under the support beam
- Possibility to manually adjust the height on one side

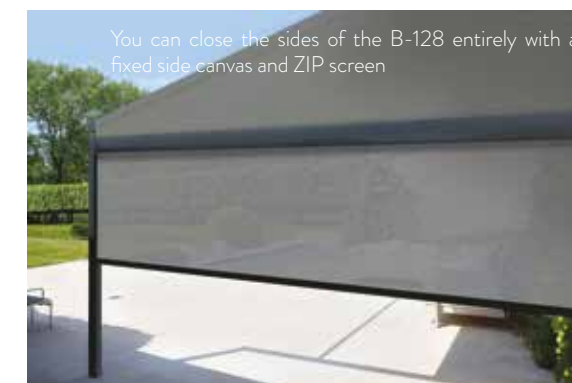

Dimensions	
Width:	max. 6 m
Projection:	max. 5 m
Operation:	Somfy RTS or IO motor
Standard colours	
RAL 9016 ST	RAL 7016 ST
All other RAL colours optional.	
Wide selection of watertight fabrics.	







B-128 VERANDA

The B-128 veranda, just like the B-128 pergola, consists of a tightly stretched canvas based on ZIP-screen technology. The canvas with the B-128 veranda is only sun-shading. The poles have been replaced by supports that are directly fastened to the veranda roof. The guides are then fixed to the supports.

- Extremely wind resistant conservatory sun protection
- Regulate the perfect amount of light and shading

Dimensions	Standard colours
Width: max. 6 m	 
Projection: max. 5 m	RAL 9016 ST RAL 7016 ST
Operation: Somfy RTS or IO motor	All other RAL colours optional. Selection of fabrics to choose from: Soltis 86/92 and acryl fabrics.







Thanks to the ZIP-screen technology the fabric is kept secure in the guide.



TOPSCREEN

The Topscreen is a windproof and anti-insect screen which covers skylights and other horizontal or inclined glass roof structures, compact porches and greenhouses. The combination of the ZIP screen technology with the tension spring system ensures the fabric stays under perfect tension at every position, even at a wind force of 6 Beaufort. The screen can be equipped with a blackout fabric.

- Compact conservatory sun protection with ZIP screen technology
- For horizontal or inclined glass structures
- Withstand against 6 Bft
- High-quality anti-solar or blackout fabric

Dimensions
Type of fabric: Soltis 86 - Soltis 92 - Blockout Lunar (Blackout)
Height: up to 3 m*
Projection: up to 3 m*
Max inclination: 0- 90°
Operation: motor with switch or with remote control
Cassette: 11 cm x 11 cm
Standard colours
   
Brustor white RAL 8019 RAL 9001 RAL 7016 ST
All other RAL colours optional.



ZIPSCREEN

The B-1085, B-1100 and B-1350 ZIP are wind resistant screens and at the same time act as an insect repellent. The unique zip system keeps the fabric locked in the side guides at every position. The ZIP screen passes the highest wind speed classification and is available with a round or square cassette, depending on the height of the screen. The maximum surface area can be 18m². The ZIP screen is also available in a coupled version.

- Wind resistant screen
- Insect repellent screen
- Round or square housing

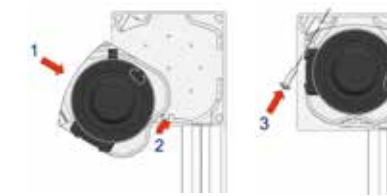

For all standard and ZIP screens, the rollertube can be removed very easily from the cassette without having to disassemble the screen.

New locking system for a better tension of the fabric.

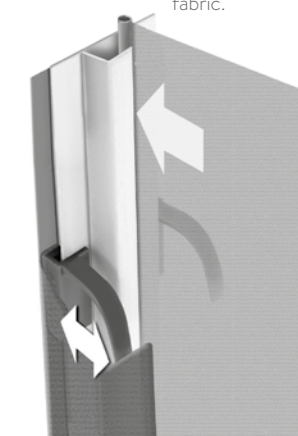

Optional solar panel with a maximum dimension of 3,5 x 3 m.



Dimensions	B-1085 SR/C ZIP	B-1100 SR/C ZIP	B-1350 C ZIP
Type of fabric:	Screen fabric (Sergé 600) - Soltis 86 - Soltis 92 - Blockout Lunar (Blackout)		
Height:	max 1,8 m	max 3,5 m	max 6,0 m
Width:	0,8 - 3,6 m	0,8 - 4,0 m	0,9 - 6,0 m
Max. width when coupled:	1,2 m - 7,2 m		not possible
Surface:	6,5 m ² - 13 m ²	14 m ² - 25,2 m ²	18 m ² / --
Dimensions cassette:	8,5 cm x 8,5 cm	10,5 cm x 10,5 cm	13,5 cm x 13,5 cm
Operation:	Somfy motor with switch (gear*)		Somfy motor with switch
Guide:	Clips or screwed rail		

* With limited dimensions the motor can be replaced by a gear.

Standard colours

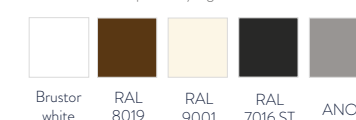

All other RAL colours optional.



Create a comfortable indoor climate whilst maintaining the view

B-1200 ZIP

The B- 1200 is fully integrated into the cavity wall and transfers seamlessly from the wall to the window. No disturbing elements that restrict visibility. According to the Brustor ZIP screen technology the screen slides fully automatic and tight through the side guides. The heavy front profile keeps the cloth tight in the side guides. The ZIP screens are the guarantee for wind resistant, sun filtering and insect-repellent window screens. The B- 1200 can be delivered in a whole range of screen fabrics. Replacing the fabric roller happens in a very simple way.

- Screen cassette and side guides can be integrated
- The lead rail disappears in the cassette
- Screen to be mounted together with the windows
- Easy access to the roller tube and fabric



Dimensions

Type of fabric: Soltis 86 - Soltis 92 - Blockout Lunar (Black-out)

Maximum height: up to 3,5 m

Maximum width: up to 5 m (coupled up to 7,2 m)

Operation: Somfy motor with switch (RTS or IO in option)

Standard colours



Brustor white RAL 7016 ST

All other RAL colours optional.

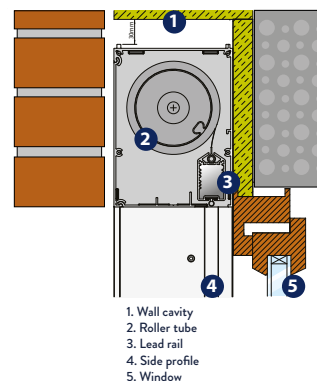

CORNER SCREEN

Our Brustor Corner screen is based on the strong, wind resistant technology of the B-1350 C built-on screen with square cassette. It is a fully automatic, panoramic screen that slides up and down in a straight angle evenly in the outer side guides. There are no disturbing profiles in the screen itself. An ideal solution for situations where the stained-glass window without support profile meet in the corner. This will provide a wide unobstructed view, while the shade will be obtained evenly in the living area.

You can command the screen by an electric motor LT, RTS or IO. With the last one you can easily control the screen with your smartphone. The motor is always located on the longest side.

- Perfect for angular constructions where the stained glass windows are connected against each other without corner profile



Dimensions

Maximum height: up to 3 m

Maximum width: up to 5 m

Operation: Somfy motor with switch (RTS or IO in option)

Standard colours



Brustor white RAL 8019 RAL 9001 RAL 7016 ST ANO
All other RAL colours optional.

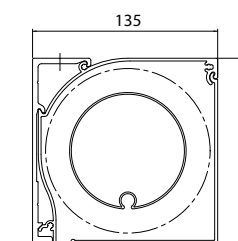

CABLE SCREEN

This budget friendly screen has a rustproof steel lead rail which is guided down by stainless steel side cables. This aesthetically pleasing and functional screen can be used inside as well as outside.

- Stylish and functional
- With stainless steel side cables
- Can be used inside as well as outside

Dimensions	
Type of fabric: screen fabric (Sergé 600), Soltis 86 - Soltis 92 - Blockout Lunar (blackout)	
Height fabric: max. 2 m	
Width: 0,60 m - 4 m (can't be coupled)	
Max surface: 8 m ²	
Cassette dimensions: 10,5 cm x 10,5 cm	
Wind resistance: CE wind class 2	
Operation: motor / gear*	
Standard colors	
	
	
	
All other RAL colours optional.	

* With limited dimensions the motor can be replaced by a gear.







STANDARD SCREEN

The vertical screens B-1085 and the B-1100 are in a compact and elegant casing, depending on the height of the window. The maximum width is 4 m and 7,20 m when coupled. The maximum height of the screen is 4 m. The small, discrete cassette makes sure that the Brustor screens matches perfectly on every façade. The screens can be produced in any RAL colour. In addition to the default screen, there is also a built-in version available.

- Vertical screens
- Maximum privacy
- With integrated motor
- Max. width 4 m



Dimensions	B-1085 SR/C	B-1100 SR/C
Type of fabric:	Screen fabric (Sergé 600)	Soltis 86 - Soltis 92
Max. height:	max 3,5 m	max 4,0 m
Width:	0,6 - 3,6 m	0,6 - 4,0 m
Max. width coupled:	1,2 m - 7,2 m	
Surface:	8 m ² - 16 m ²	
Dimensions cassette:	8,5 cm x 8,5 cm	11 cm x 11 cm
Operation:	motor (gear*)	

Standard colours				
				
Brustor white	RAL 8019	RAL 9001	RAL 7016 ST	ANO
All other RAL colours optional.				



* With limited dimensions the motor can be replaced by a gear.



B-2100 DROP ARM AWNING

The Brustor B-2100 is a drop arm awning with wind resistant side arms. The fabric is covered in an extruded aluminium, powdercoated, full cassette casing. Thanks to the heavy duty springs in the arms, the fabric stays taut at every position. The B-2100 awning can drop up to 90° or 135°. The maximum width is 5 m for a single unit and 6 m for a coupled one. The standard motor can be replaced by an optional gear.

- Wind resistant awning
- Inclination up to 90° or 135°
- Max. width 5 m

Dimensions	
Type of fabric: Screen, Soltis, Acryl	
Width fabric: 0,65 m - 5 m (coupled up to 6 m)	
Projection: 0,80 m - 1 m - 1,20 m - 1,40 m (depending on width and fabric)	
Max inclination: up to 90° or 135°	
Operation: motor (gear optional)	
Cassette: 12,8 cm x 12,8 cm	
Standart colours	
	
	
All other RAL colours optional.	



BRUSTOR

SPECIALISTS IN OUTDOOR LIVING, AWNINGS & SCREENS

Brustor is a family business who manufactures outdoor living pods, awnings and screens for decades. Innovation, quality and a high level are still the key to our success. Together with our many years' experience, we are able to respond to every demand.

LEADING COMPANY IN EUROPE

Through the years Brustor, a family business, has become a strong player in the international market of sun protection. The in-house production occurs in our new, 50.000m² production hall in Gullegem (BE), from where our products are transported worldwide to 30 countries. Even our warehouse continues to grow so we are able to supply the orders very quickly.

OUR PEOPLE MAKE THE DIFFERENCE

Our most important capital are our employees. Highly skilled people who always go the extra mile. Whether they are operating machines with greatest precision, accomplishing a commercial role, implementing installations or studying innovating techniques; each and every one of them is an experienced, motivated, customer orientated person with a passion for quality.

STATE-OF-THE-ART MACHINES

Top quality products demand well-oiled machinery capable of handling the most advanced production and assembly techniques. Operated by highly trained people, our state-of-the-art machines are the acme of precision. High productivity guaranteed. Thanks to a modern powdercoating system, each colour can be achieved on our own site.

MORE INFO OR QUESTIONS?

Muizelstraat 20, 8560 Gullegem, Belgium
T +32(0)56 53 18 53
www.brustor.com
info@brustor.com



OPTIONS AND TECHNICAL INFO

	FULLY ENCLOSED CASSETTE	2 CABLES ARM 66MM 5 BEAUFORT	4 CABLES ARM 71MM 5 BEAUFORT	4 CABLES ARM 73MM 6 BEAUFORT	MAXIMUM WIDTH	MAXIMUM PROJECTION	MOTOR WITH SWITCH	MOTOR WITH REMOTE CONTROL	MOTOR WITH EMERGENCY OVERRIDE	LED STRIP COMPLETE ARM	INTEGRATED LED SPOT IN ELBOW	LED STRIP UNDER THE CASSETTE	BRUSTOR WHITE	RAL 8019 BROWN	RAL 9001 CREAM	RAL 7016 ANTHRACITE GREY (TEXT.)	ANODISED 20µM	VALANCE
B24 Elite	✓	x	✓	x	14	3,75	✓	option	option	option	x	option	✓	✓	✓	✓	✓	✓
B24 Prestige	✓	x	x	✓	14	3,75	x	✓	option	x	option	option	ALL RAL COLOURS FREE				✓	
B27	✓	✓	x	x	14	3	✓	option	option	x	x	option	✓	✓	✓	✓	✓	✓
B27 Elite	✓	x	✓	x	14	3,75	✓	option	option	✓	x	option	✓	✓	✓	✓	✓	✓
B27 Prestige	✓	x	x	✓	14	3,75	x	✓	option	x	option	option	ALL RAL COLOURS FREE				✓	
B28	✓	✓	x	x	14	3	✓	option	option	x	x	option	✓	✓	✓	✓	✓	✓
B28 Elite	✓	x	✓	x	14	3,75	✓	option	option	option	x	option	✓	✓	✓	✓	✓	✓
B28 Prestige	✓	x	x	✓	14	3,75	x	✓	option	x	option	option	ALL RAL COLOURS FREE				✓	
B35	option	x	x	x	15	4	✓	option	option	option	x	option	✓	✓	✓	✓	✓	✓
B35 Prestige	option	x	x	✓	15	4	x	✓	option	x	option	option	✓	✓	✓	✓	✓	✓
B38	option	x	x	x	6	3,5	✓	option	option	option	x	option	✓	✓	✓	✓	✓	✓
B38 Prestige	option	x	x	✓	6	3,5	x	✓	option	x	option	option	✓	✓	✓	✓	✓	✓
B50	✓	✓	x	x	5,5/5	3/2,5	✓	option	x	x	x	x	✓	✓	✓	✓	✓	✓
B50 XL	✓	x	✓	x	6/5,5	3/3,5	✓	option	x	✓	x	option	✓	✓	✓	✓	✓	✓
B29	✓	✓	x	x	6	3	✓	option	x	option	x	option	✓	option	option	option	x	✓
B34	x	✓	x	x	6	3	✓	option	x	x	x	option	✓	option	option	option	x	✓
B40	option	x	x	x	7	3,5	✓	option	x	x	x	x	option	option	option	option	✓	x
B20	x	✓	x	x	5/5,5	3/2,5	✓	option	x	x	x	x	✓	option	✓	option	x	✓
B21	x	✓	x	x	5/5,5	3/2,5	✓	option	x	x	x	x	✓	option	✓	option	x	✓

Your Brustor dealer

BRUSTOR[®]
OUTDOOR SUN SYSTEMS

Muizelstraat 20 | 8560 Gullegem | Belgium
T +32 (0)56 53 18 53 | info@brustor.com

WWW.BRUSTOR.COM

